



ISSN: 0975-833X

RESEARCH ARTICLE

MODIFIED DYNAMIC SET POINT WEIGHTED CONTROLLER FOR VARIOUS SAMPLING PERIOD

***Florance Mary, M. and Ananda Natarajan, R.**

Department of Electronics and Instrumentation, Pondicherry Engineering College, Puducherry, India

ARTICLE INFO

Article History:

Received 21st December, 2014
Received in revised form
04th January, 2015
Accepted 25th February, 2015
Published online 31st March, 2015

Key words:

Modified DSPWPI,
DSPWPI,
Sampling Period Selection

ABSTRACT

The property of traditional Ziegler–Nichols tuned PI controllers (ZNPIs) are simple tuning rules with excessive oscillation and large overshoot. However, both the fixed set point weighted PI (FSWPI) and ZNPI exhibit equally poor load regulation. Dynamic set point weighted PI controller (DSPWPI) shows better response than FSPWPI and ZNPI but only for very low sampling period. Here, an online modified dynamic set-point weighting technique (MDSPWPI) is proposed. Performance of the proposed modified dynamic set-point weighting based PI controller (MDSPWPI) for various processes shows a significant improvement and stable response for set point change at allowable sampling period range.

Copyright © 2015 Florance Mary and Ananda Natarajan. This is an open access article distributed under the Creative Commons Attribution License, which permits unrestricted use, distribution, and reproduction in any medium, provided the original work is properly cited.

INTRODUCTION

Currently, more than half of the controllers used in industry are PID controllers. In the past, many of these controllers were analog. However, many of today's controllers use digital signals and computers. When a mathematical model of a system is available, the parameters of the controller can be explicitly determined. However, when a mathematical model is unavailable, the parameters must be determined experimentally. Controller tuning is the process of determining the controller parameters which produce the desired output. Controller tuning allows for optimization of a process and minimizes the error between the variable of the process and its set point. The Ziegler–Nichols tuning method is a heuristic method of tuning a PID controller (Ziegler and Nichols, 1942). All books on process control have a chapter on tuning of PID controllers and a large number of papers have also appeared. However, performances of ZNPIs under both set-point change and load disturbance are not satisfactory for high-order processes due to excessive oscillation associated with a large overshoot and poor load regulation (Astrom and Hagglund, 1995; Astrom and Hagglund, 2004; Astrom and Hagglund, 2001). The rules do, however, have severe drawbacks, since they use insufficient process information and the design criterion gives closed loop systems with poor robustness.

Many studies in the literature also indicate that by a numerical approach for the fractional order proportional-integral-derivative controller (FO-PID) design can be used for the unstable first order time delay system. The controller design is based on the system time delay (Hamideh Hamidian and Ali Akbar Jalali, 2011). The dynamic set-point weighting factor (β_a) for dynamic set point weighted PI (Rajani and Mudi, 2011) is heuristically derived from the instantaneous process trend. The Performance of the dynamic set-point weighting based PI controller (DSPWPI) does not show good results for the sampling range specified by control theory (William and Levine, 1995). The Performance of the proposed modified dynamic set-point weighting based PI controller (MDSPWPI) shows better results than PI and DSPWPI for allowable sampling period range. In this work, the performance of the PI controller with modified dynamic set-point weighting (MDSPWPI) is proposed and tested for various process and the value of the tuning parameter γ is also proposed. Performance comparison shows that our proposed technique is capable of providing satisfactory response for various process models at all allowable sampling period.

Rest of the paper is organized as follows

Section 2 describes the structure of the proposed Modified dynamic set point weighting based PI controller. Simulation study on various process models is given in Section 3. Conclusions are drawn in the final Section 4.

*Corresponding author: **Florance Mary, M.**
Department of Electronics and Instrumentation, Pondicherry
Engineering College, Puducherry, India.

Modified Dynamic Set-Point Weighting Method

The block diagram of the proposed MDSPWPI is shown in Fig. 1. The weighted set point for the proportional action is calculated online by the dynamic weighting factor β_d based on error change. When the output of the process is trying to move towards its set point, proportional action should be reduced to prevent possibly large overshoot, on the other hand, when the process is moving away from the set point, proportional action should be increased to restrict such deviations, for the process output to reach its desired value at the earliest. Hence the dynamic set point weighting factor β_d is made proportional to instantaneous change in error as shown in equation (1) and (3).

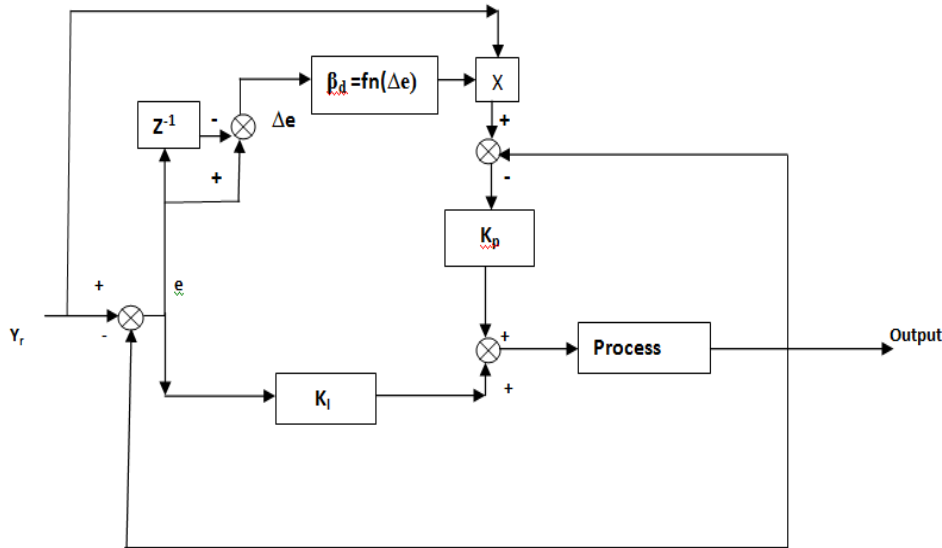

Fig.1. Block diagram of MDSPWPI

$$\beta_d(k) = \{1 + \gamma \times \theta \times \Delta e(k)\} \dots\dots\dots (1)$$

$$\gamma = Fn(K_p, K_u, T_u) \dots\dots\dots (2)$$

$$\theta = \frac{\pi - 2 \arctan(\sqrt{K_u K_p - 1})}{2.72 \sqrt{K_u K_p - 1}} \dots\dots\dots (3)$$

Where $\beta_d(k)$ is the dynamic weighting factor, respectively at k^{th} instant. γ is the proposed tuning parameter, θ is the normalized dead time of the process and fn stands for the function of. Here, we propose the tuning of γ , which is developed through an simulation study on a wide range of processes. Here, γ is a function of K_p , K_u and T_u where K_u and T_u are the ultimate gain and ultimate period and K_p is process gain respectively. $\Delta e(k)$ is the change of error at k^{th} instant.

Simulation Studies

The proposed MDSPWPI is tested through simulation experiments on different types of process models for verification.

The model considered are higher order integrating process, Second-order marginally stable process, second-order linear process and first order process.

Higher order integrating process

We observed the performance of MDSPWPI for a unity feedback system of

$$G_p(s) = \frac{25(s+10)}{s(s^2+9s+40)(s+4)} \dots\dots\dots (4)$$

The value for γ is 0.6118 for this process. The frequency response of this system shows a gain cross over frequency of $\omega_0 = 1.572 \frac{rad}{sec}$. As per the rule, given in (William, 1995), (Åström and Wittenmark, 1987) the sample period range is 0.095 to 0.32. The system is tested for different controllers in this range and was found that DSPWPI has an increased oscillation as the sampling period increases and becomes unstable. Performance of the system is shown in Fig. 2 to Fig. 4. Its performance analysis for different controllers is presented in Table 1. Here, it is found that DSPWPI is not suitable for the allowable sampling range.

When compares with conventional PI, proposed MDSPWPI has less overshoot. This comparison is also shown in Table 1.

Second-order marginally stable process

Transfer function of the second-order marginally stable process is

$$G_p(s) = \frac{e^{-0.3s}}{s(s+1)} \dots\dots\dots (5)$$

Table 1. Performance Analysis for set point change of the process in (4)

SAMPLING TIME IN SEC	ZNPI		DSPWPI		PROPOSED MDSPWPI		% OVERSHOOT	
	IAE	ISE	IAE	ISE	IAE	ISE	PI	MDSPWPI
0.095	1.892	0.9542	0.9321	1.127	1.568	0.8321	85.5	79.5
0.2	1.892	0.9542	11.44	11.42	1.397	0.7988	85.5	75.5
0.32	1.892	0.9542	$1.48e^9$	$8.77e^{17}$	1.43	0.8584	85.5	74.2

MDSPWPI – Modified Dynamic Set Point Weighted PI controller

DSPWPI – Dynamic Set Point Weighted PI controller

PI- Zeigler Nichols PI controller

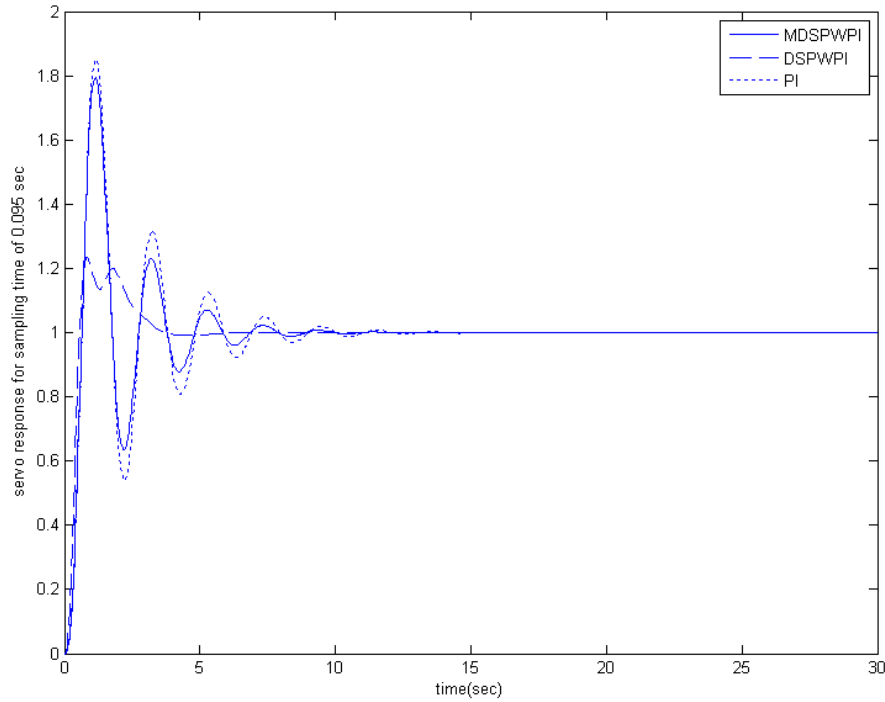

Fig. 2. Response for system (4) for a sampling time of 0.095sec

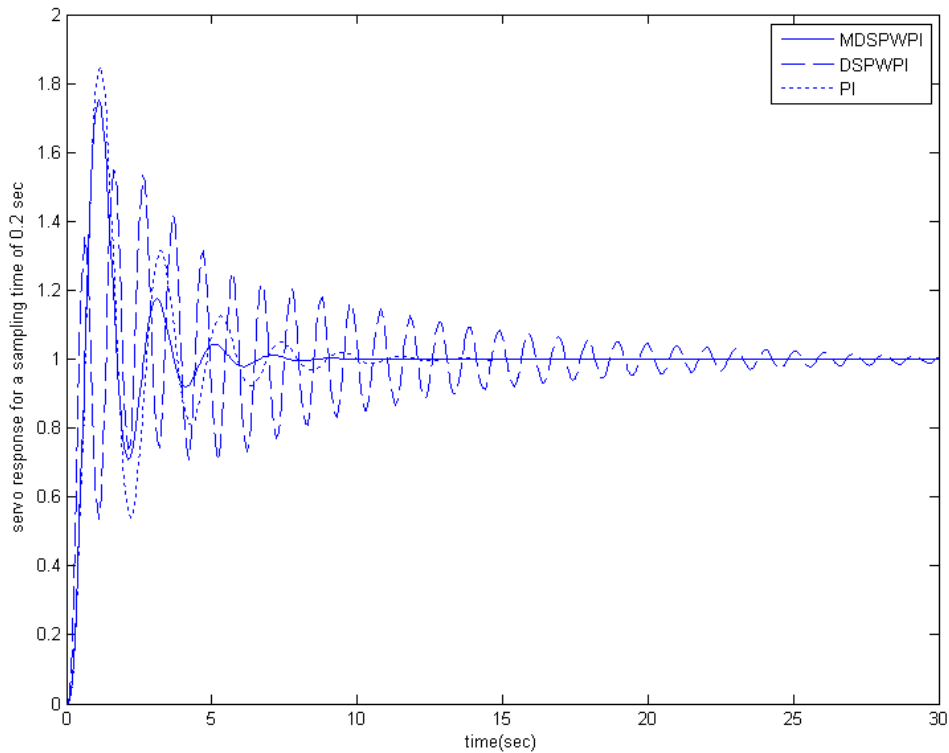

Fig. 3. Response for system (4) for a sampling time of 0.2sec

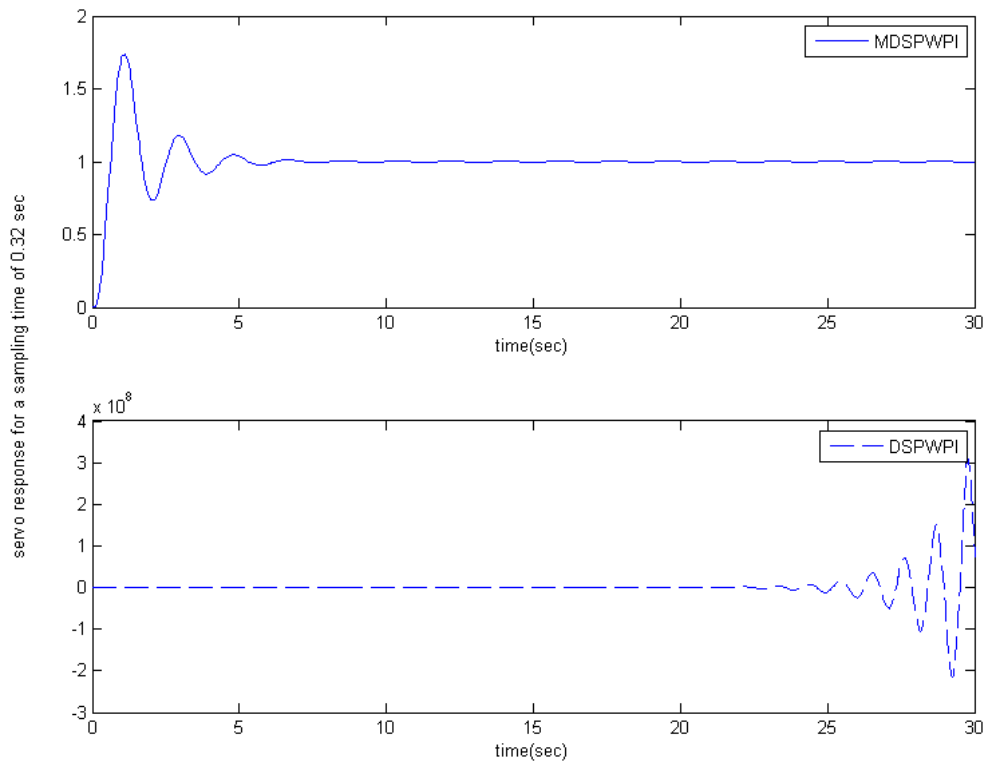
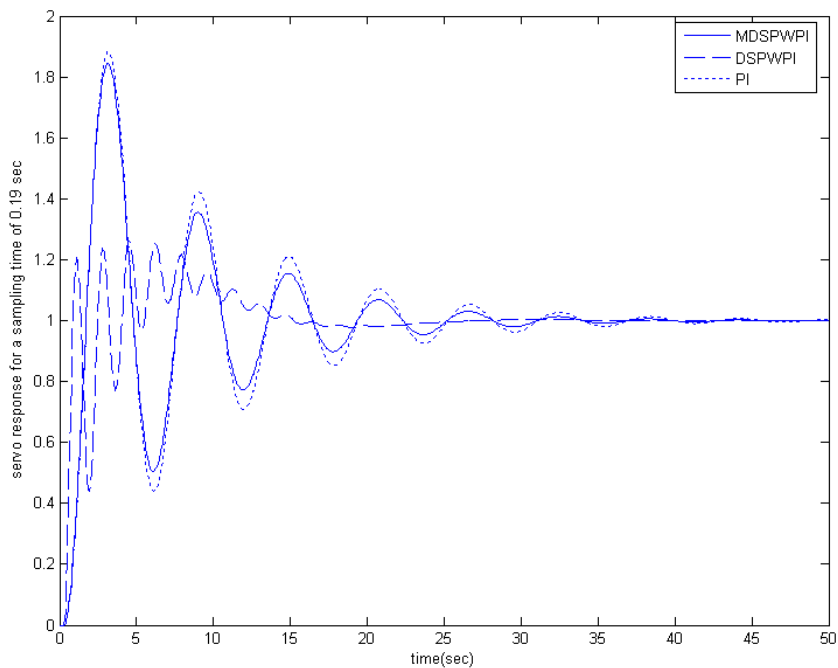

Fig. 4. Response for system(4) for a sampling time of 0.32sec



The value for γ is 0.2696 for this process. The frequency response of this system shows a gain cross over frequency of $\omega_0 = 0.786 \frac{\text{rad}}{\text{sec}}$. As per the rule given in (William, 1995), (Åström and Wittenmark, 1987), the sample period range is 0.1908 to 0.6361. The system is tested for different controllers in this range and was found that DSPWPI has an increased oscillation as the sampling period increases and becomes unstable.

Performance of the system is shown in Fig. 5 to Fig. 7. Its performance analysis for different controllers is presented in Table 2. Here, it is found that DSPWPI is not suitable for the allowable sampling range. When compared with conventional PI, proposed MDSPWPI has less overshoot. This comparison is also shown in Table 2.

Table 2. Performance Analysis for set point change of the process in (5)

SAMPLING TIME IN SEC	ZNPI		DSPWPI		PROPOSED MDSPWPI		% OVERSHOOT	
	IAE	ISE	IAE	ISE	IAE	ISE	PI	MDSPWPI
0.1908	6.58	3.141	14.04	42.5	5.676	2.775	88.5	84.4
0.2	6.58	3.141	19.72	57.77	5.637	2.759	88.5	84
0.4	6.58	3.141	$1.389e^{17}$	$9.86e^{33}$	5.027	2.56	88.5	81
0.6361	6.58	3.141	$9.32e^{22}$	$5.066e^{45}$	4.663	2.499	88.5	78.7

MDSPWPI – Modified Dynamic Set Point Weighted PI controller

DSPWPI – Dynamic Set Point Weighted PI controller

PI- Zeigler Nichols PI controller

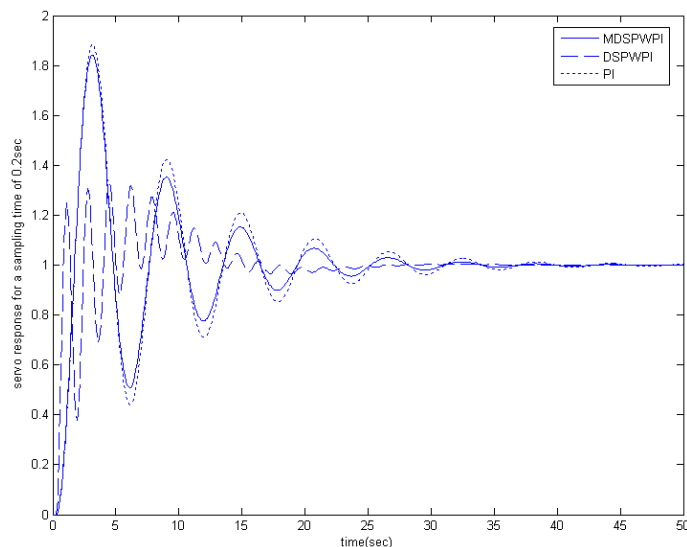

Fig. 6. Response for system(5) for a sampling time of 0.2sec

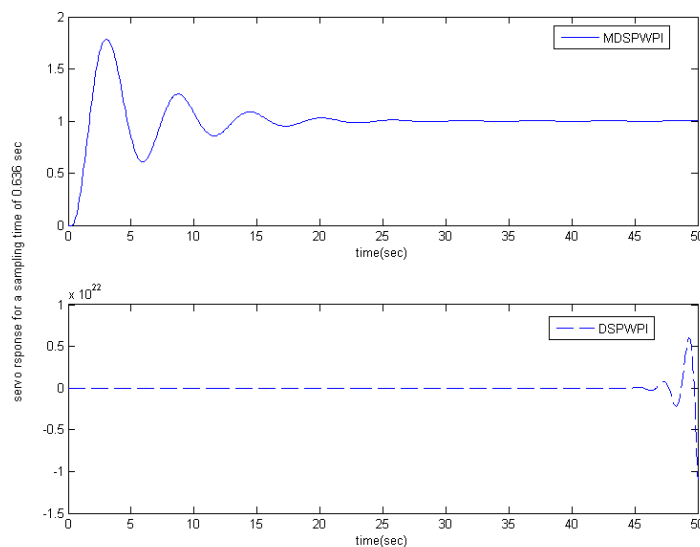

Fig. 7. Response for system(5) for a sampling time of 0.6361sec

Table 3. Performance Analysis for set point change of the process in (6)

SAMPLING TIME IN SEC	ZNPI		DSPWPI		PROPOSED MDSPWPI		% OVERSHOOT	
	IAE	ISE	IAE	ISE	IAE	ISE	PI	MDSPWPI
0.1998	1.256	0.4046	2.631	8.539	1.204	0.5934	26.1	24.5
0.5	1.256	0.4046	55.15	192.1	1.175	0.6082	26.1	22.7
1	1.256	0.4046	22.4	58.51	1.279	0.6868	26.1	23.5
1.3320	1.256	0.4046	17.62	24.9	1.384	0.6826	26.1	25

MDSPWPI – Modified Dynamic Set Point Weighted PI controller

DSPWPI – Dynamic Set Point Weighted PI controller

PI- Zeigler Nichols PI controller

Table 4. Performance Analysis for set point change of the process in (7)

SAMPLING TIME IN SEC	ZNPI		DSPWPI		PROPOSED MDSPWPI		% OVERSHOOT	
	IAE	ISE	IAE	ISE	IAE	ISE	PI	MDSPWPI
0.418	0.9518	0.524	3.917	6.425	0.9415	0.560	15.2	13.5
1	0.9518	0.524	6.536	7.502	1.056	0.6217	15.2	9.7
2.5	0.9518	0.524	9.155	9.617	1.258	0.6467	15.2	12.6

MDSPWPI – Modified Dynamic Set Point Weighted PI controller

DSPWPI – Dynamic Set Point Weighted PI controller

PI- Zeigler Nichols PI controller

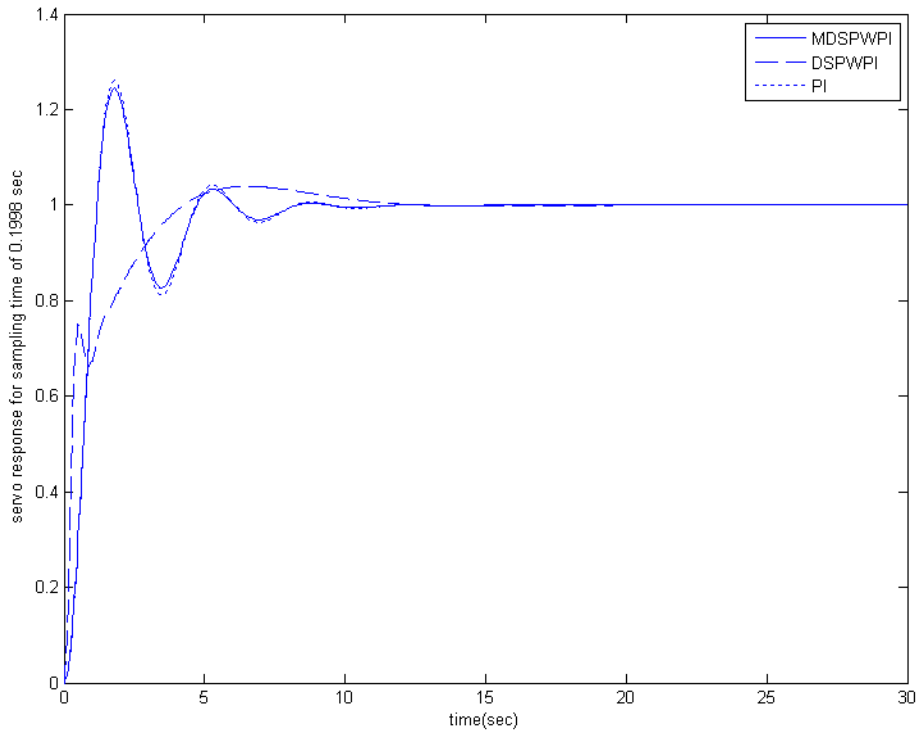

Fig. 8. Response for system(6) for a sampling time of 0.1998sec

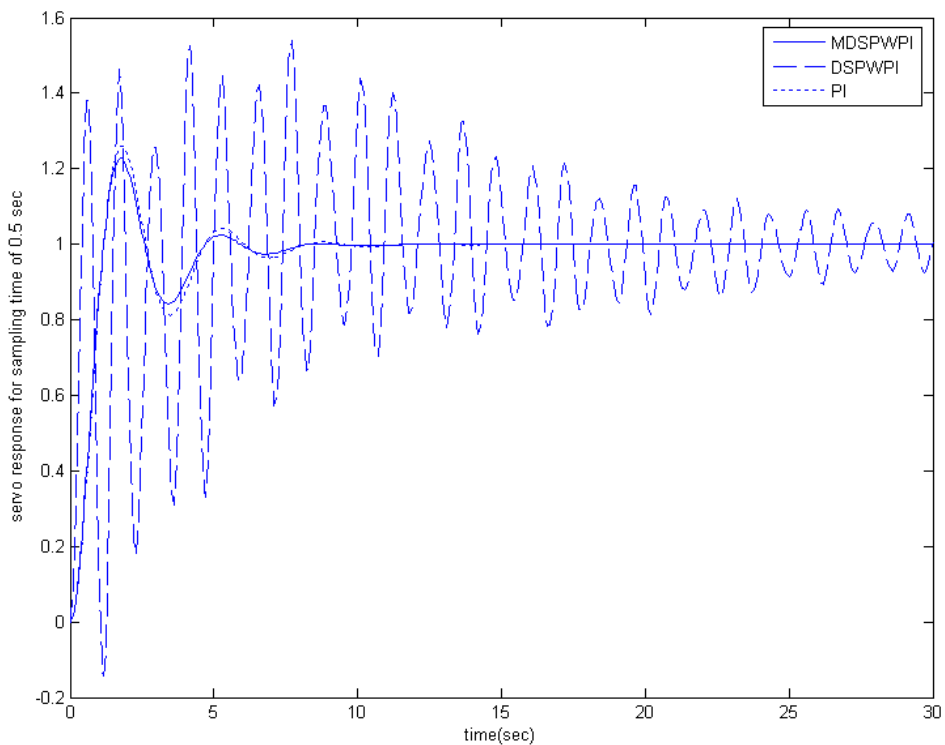

Fig.9. Response for system (6) for a sampling time of 0.5sec

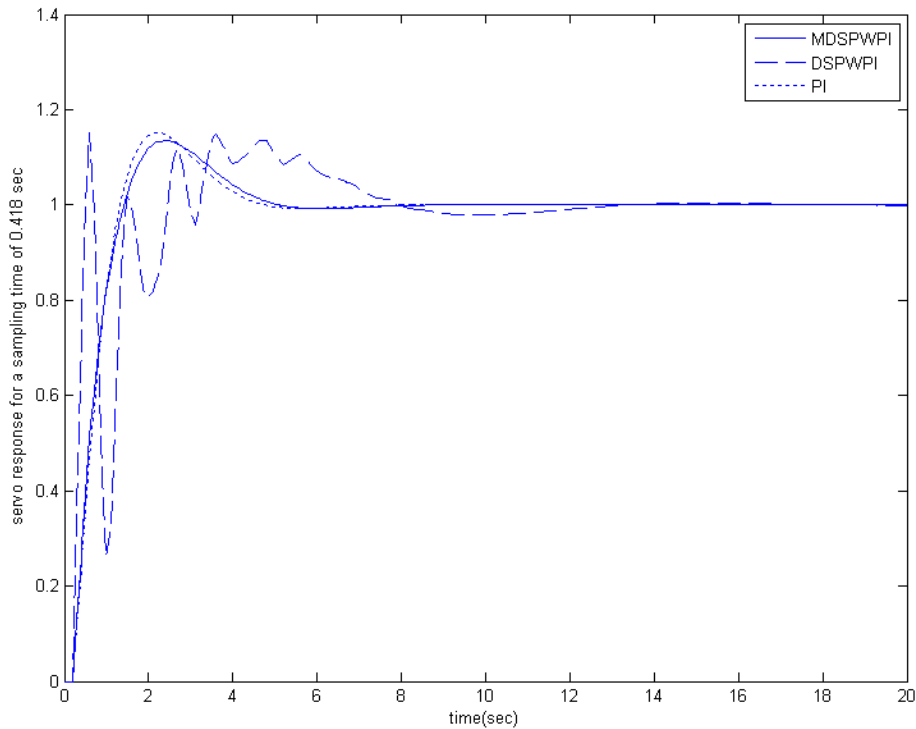

Fig.10. Response for system (7) for a sampling time of 0.418sec

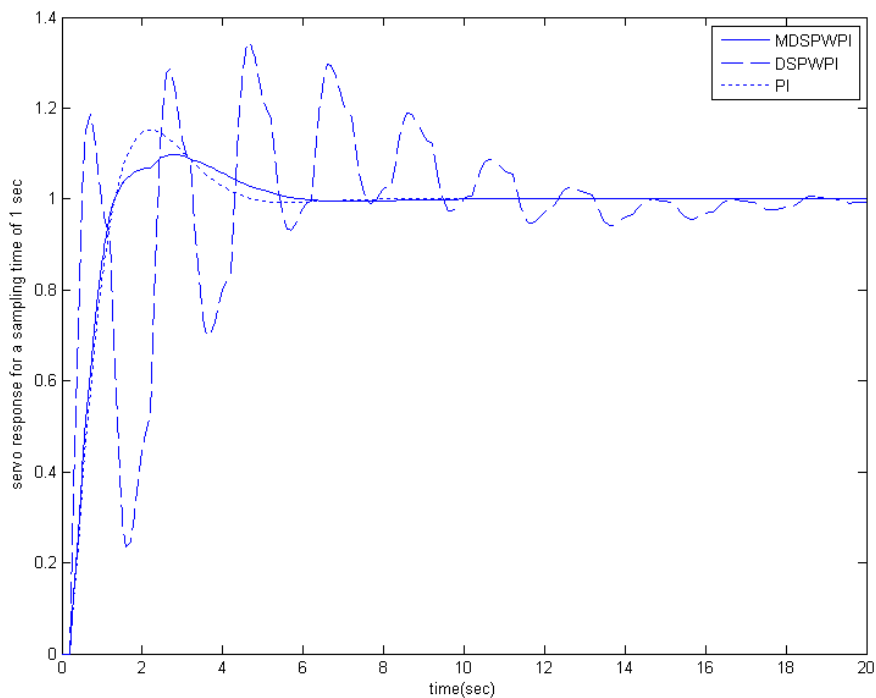

Fig.11. Response for system (7) for a sampling time of 1sec

Second-order linear process

A second-order linear process is expressed by the following transfer function:

$$G_p(s) = \frac{e^{-0.2s}}{(s^2 + 1.41s + 1)} \dots\dots\dots (6)$$

The value for γ is 0.2532 for this process. As per the rule specified in (William, 1995) based on the damping ratio and rise time, the sampling period range is 0.1998 to 1.332. Performance of the system is shown in Fig. 8 and Fig. 9. Its performance analysis for different controllers is presented in Table 3. Here, it is found that proposed MDSPWPI gives better response than ZNPI and MDSPWPI at all allowable sampling period.

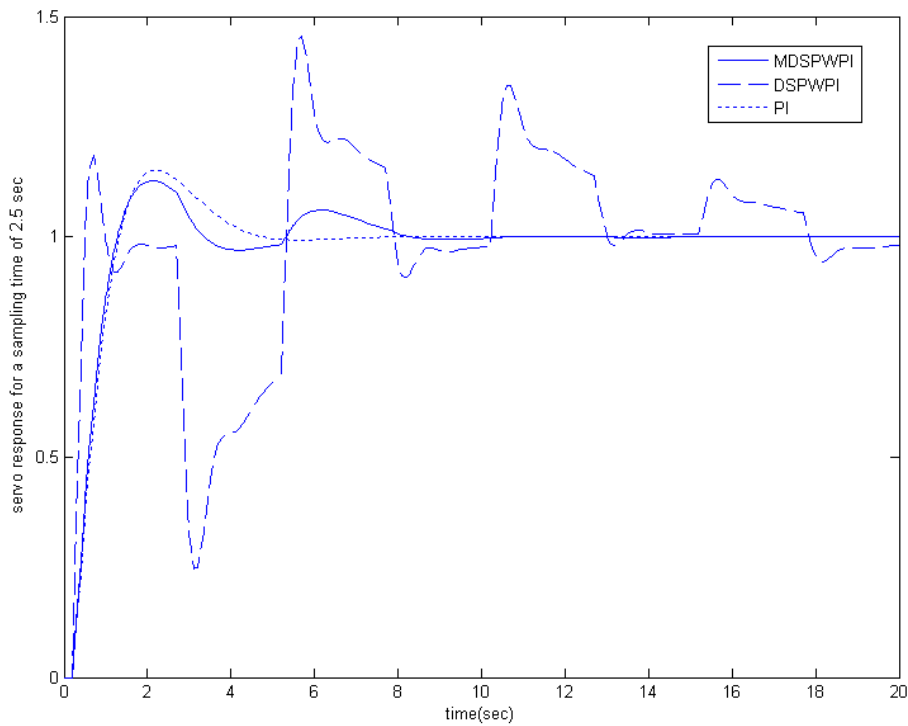

Fig.12. Response for system (7) for a sampling time of 2.5 sec

Here, as the sampling period is increased the oscillation increases for DSPWPI with high ISE and IAE values. The performance analysis shows that for the allowable range, proposed MDSPWPI shows comparatively less overshoot than conventional PI.

First order linear process

A second-order linear process is expressed by the following transfer function:

$$G_p(s) = \frac{1}{(2s+1)} \dots\dots\dots (7)$$

The value for γ is 0.4264 for this process. As per the rule specified in (William, 1995) based on the time constant and rise time, the sampling period range is 0.4180 to 2.508. Performance of the system is shown in Fig. 10 to Fig 12. Its performance analysis for different controllers is presented in Table 4. Here, it is found that proposed MDSPWPI gives better response than ZNPI and MDSPWPI at all allowable sampling period. Here, as the sampling period is increased the oscillation increases for DSPWPI with high ISE and IAE values. The performance analysis shows that for the allowable range, proposed MDSPWPI shows comparatively less overshoot than conventional PI.

Conclusion

A new dimension to dynamic set point weighted PI controller is presented. The performance of the PI controller with proposed modified dynamic set-point weighting (DSPWPI) is tested for wide range of process and the value for the tuning parameter γ is also proposed.

The results demonstrate the better performance of the proposed modified dynamic set point weighted PI control scheme used in this paper compared with Ziegler Nichols PI controller and dynamic set point weighted controller for all allowable sampling period with less overshoot and less oscillation.

REFERENCES

Astrom, K.J. and Hagglund, T. 2001. The future of PID control, *Control Engineering Practice* 9 1163–1175.
 Astrom, K.J. and Hagglund, T. 2004. "Revisiting the Ziegler–Nichols step response method for PID control", *Journal of Process Control*, 14 635–650.
 Astrom, K.J. and Hagglund, T. 1995. "PID Controller: Theory, Design and Tuning", 2nded. Research Triangle park, NC: Instrum.Soc.Amer.
 Åström, K.J. and Wittenmark, B. 1987. Computer Controlled system, Prentice Hall, Englewood Cliffs, N.J.
 Hamideh Hamidian and Ali Akbar Jalali, March-2011. Calculation of PID Controller Parameters for Unstable First Order Time Delay Systems, *International Journal of Scientific and Engineering Research*, Volume 2, Issue 3.
 Rajani, K., Mudi, Chanchal Dey, B. 2011. Performance improvement of PI controllers through dynamic set-point weighting, *ISA Transactions* 50 220–230.
 William, S. Levine, 1995. The control handbook, CRC press and IEEE press, Pg 313-320.
 Ziegler, J.G. and Nichols, N.B. 1942. Optimum settings for automatic controllers, *Trans. ASME* 64 759–768.
